

The Impact of the I/Q Mismatching Errors on the BER Performance of OFDM Communication Systems

Nguyen Thanh Hieu¹, Heung-Gyoon Ryu¹,

Cheng-Xiang Wang²,

and Hsiao-Hwa Chen³

¹Department of Electronic Engineering,
Chungbuk National University,
Chungbuk, 361-763, KOREA.

E-mail: nguyenthanhhieu@yahoo.com,
ecomm@cbu.ac.kr

²JRI in SIP, School of EPS,
Heriot-Watt University,
Edinburgh EH14 4AS, UK.

E-mail: cheng-xiang.wang@hw.ac.uk

³Institute of Communications Engineering,
National Sun Yat-Sen University
Taiwan 804, ROC

E-mail: hshwchen@iee.org

Abstract- Orthogonal frequency division multiplexing (OFDM) signals are very sensitive to radio frequency (RF) impairments. One of the major impairments is the mismatching errors between the in-phase (I) and quadrature (Q) branches in the up and down-conversions. The I/Q mismatching errors can include phase and amplitude mismatching errors. These mismatching errors make the signal constellation expand and rotate, which severely degrades the performance of OFDM systems. In this paper, a closed-form expression for the bit error rate (BER) of the OFDM system in I/Q mismatching error environments is derived as a function of phase and amplitude mismatching error parameters. This enables a convenient and useful evaluation of the performance of OFDM communication systems with I/Q mismatching errors. The derived analytical expression is validated by the fact that computer simulation results closely match with the analytical derivation results.

I. INTRODUCTION

OFDM is an attractive modulation technique in wireless applications by dividing a frequency-selective channel into several frequency-flat sub-channels, which provides good immunity to the multi-path fading. Due to its promising advantages, OFDM has been adopted in several modern communication systems such as wireless local area network (WLAN) IEEE 802.11a [1], wireless metropolitan area network (WMAN) IEEE 802.16a [2], digital audio broadcasting (DAB), and digital video broadcasting (DVB-T) [3]. OFDM is also a potential candidate for the fourth generation (4G) mobile wireless systems. However, OFDM signals are sensitive to impairments of radio frequency (RF) front-end components. A major source of impairments is the mismatching error between I/Q components of the signal.

In this paper, we will study the impact of I/Q mismatching error on the BER performance of an OFDM system. Usually, a base-band signal is up-converted to a RF before the transmission to the channel over an antenna. At the receiver side, the RF signal is down-converted to the base-band and processed digitally. The up-conversion of a complex OFDM signal requires both cosine and sine waveforms. Due to manufacturing inaccuracies, the cosine and sine waveforms often do not have the same waveform and the phase shift between them is often not 90° . I/Q mismatching error can result in the significant degradation of the BER performance of

OFDM systems. The effects of I/Q mismatching errors have been investigated in some papers. In [4], [5], up-conversion, down-conversion, and I/Q mismatching errors in the analog domain were studied. A model for the phase and amplitude mismatch was introduced in [6]. The effect of I/Q mismatching error on OFDM systems was investigated in [7], [8]. In [9], simulation results showed the limit of I/Q mismatching error in MIMO-OFDM systems. The authors also designed a MIMO receiver architecture that is robust to I/Q mismatching error by exploiting the structure of orthogonal space-time codes. In [10], the authors proposed an estimation technique for calculating mismatching error parameters. Estimated parameters were used to calibrate the receiver mismatching error. I/Q mismatching error and several other impairments such as phase noise and frequency offset were investigated in [11], [12]. These papers considered additional effects from channel estimation on I/Q compensation and the procedure to compensate. However, the relationship between I/Q mismatching error and the performance degradation of OFDM systems was not derived in a closed-form. This paper aims to fill this gap.

In this paper, we investigate the BER performance of an OFDM system in I/Q mismatching error environment. A closed-form expression for the BER of the OFDM system with mismatching error parameters will be derived. The obtained closed-form expression for the BER is represented as a function of phase and amplitude mismatching error parameters. Computer simulations are carried out to verify the analytical derivation.

II. SYSTEM DESCRIPTION

A simple block diagram of the OFDM transmitter is illustrated in Fig.1. Let $X = [X_0, X_1, \dots, X_{N-1}]^T$ denote the input data after the serial to parallel (S/P) converter. The inverse fast Fourier transform (IFFT) will convert a signal from the frequency domain to the time domain.

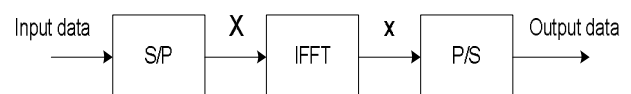

Fig. 1. A simple block diagram of the OFDM transmitter.

After the IFFT, the complex base-band OFDM signal is

$$x(t) = \frac{1}{N} \sum_{n=0}^{N-1} X_n e^{j2\pi\Delta f t}, \quad 0 \leq t < NT \quad (1)$$

where T is the data period, NT is the OFDM symbol duration, and $\Delta f = \frac{1}{NT}$ is the sub-carrier spacing. The time domain OFDM signal is then converted from parallel to serial (P/S) before the transmission.

Let the sequence $x = [x_0, x_1, \dots, x_{LN-1}]^T$ represent the sampled time domain signal $x(t)$. The so-called over-sampling factor L is an integer larger than or equal to 1. When $L=1$, the samples are obtained by use of the Nyquist sampling rate. The “ L -time over-sampled” time domain signal samples can be expressed by

$$x_k = \frac{1}{N} \sum_{n=0}^{N-1} X_n e^{j2\pi\frac{nk}{LN}}, \quad k = 0, 1, \dots, LN-1. \quad (2)$$

From (2), we can also write $x = \text{IFFT}(X)$. In this paper, we will only consider the case $L=1$.

The carrier modulation of a signal to the RF is often implemented by the quadrature modulation method. Let us use $I(t)$ and $Q(t)$ to denote the I component and Q component of $x(t)$, respectively. A local oscillator (LO) can be employed to generate the sine waveform for the I branch and phase shifted by 90° to generate the cosine waveform for the Q branch. Ideally, the transmitted RF signal without the I/Q mismatching error is given by

$$s(t) = I(t)\cos \omega_c t + Q(t)\sin \omega_c t \quad (3)$$

where ω_c is the carrier angle frequency. As shown in [6], the mismatching error between the I and Q branches often occurs. Fig. 2 demonstrates an OFDM transmitter with both amplitude and phase I/Q mismatching errors. In this case, the transmitted RF signal is given by

$$\hat{s}(t) = I\left(1 + \frac{\varepsilon}{2}\right)\cos\left(\omega_c t + \frac{\phi}{2}\right) + Q\left(1 - \frac{\varepsilon}{2}\right)\sin\left(\omega_c t - \frac{\phi}{2}\right) \quad (4)$$

where ε and ϕ denote the amplitude and phase mismatching errors, respectively.

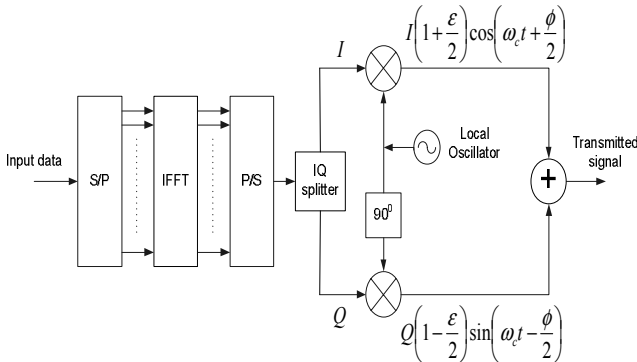

Fig.2. An OFDM transmitter with I/Q mismatching errors.

At the receiver side, the corresponding quadrature demodulation is applied. The I and Q components of the

received signal are multiplied with the recovered carriers $\cos \omega_c t$ and $\sin \omega_c t$, respectively. After low-pass filtering, the quadrature components of the signal are then combined at the I/Q combiner. Under the assumption of a noise-free channel, the output signal of the I/Q combiner is

$$r(t) = \left[I\left(1 + \frac{\varepsilon}{2}\right)\cos\frac{\phi}{2} - Q\left(1 + \frac{\varepsilon}{2}\right)\sin\frac{\phi}{2} \right] + j \left[-I\left(1 - \frac{\varepsilon}{2}\right)\sin\frac{\phi}{2} + Q\left(1 - \frac{\varepsilon}{2}\right)\cos\frac{\phi}{2} \right]. \quad (5)$$

After some calculations [13], we have

$$r(t) = \left(\cos\frac{\phi}{2} + j\frac{\varepsilon}{2}\sin\frac{\phi}{2} \right) x(t) + \left(\frac{\varepsilon}{2}\cos\frac{\phi}{2} - j\sin\frac{\phi}{2} \right) x^*(t) \quad (6)$$

where $x(t) = I(t) + jQ(t)$ and $x^*(t)$ denotes the conjugate of $x(t)$. Note that we can also rewrite (6) as

$$r(t) = \alpha_1 x(t) + \alpha_2 x^*(t) \quad (7)$$

with

$$\alpha_1 = \cos\frac{\phi}{2} + j\frac{\varepsilon}{2}\sin\frac{\phi}{2} \quad (8)$$

$$\alpha_2 = \frac{\varepsilon}{2}\cos\frac{\phi}{2} - j\sin\frac{\phi}{2}. \quad (9)$$

After the down-conversion, the complex base-band signal $r(t)$ is sent to the OFDM demodulation. The discrete form of $r(t)$ is then converted from serial to parallel, denoting as $r = [r_0, r_1, \dots, r_{N-1}]^T$. Taking the FFT operation, we have

$$R = \alpha_1 X + \alpha_2 X^* \quad (10)$$

where $R = \text{FFT}(r) = [R_0, R_1, \dots, R_{N-1}]^T$,

$$X = \text{FFT}(x) = [X_0, X_1, \dots, X_{N-1}]^T \text{ and}$$

$$X^* = \text{FFT}(x^*) = [X_0^*, X_{N-1}^*, \dots, X_{N/2}^*, X_{N/2-1}^*, \dots, X_1^*]^T.$$

The received signal is scaled by α_1 and interfered by the mirror image (complex conjugate is scaled by α_2). The second component of the right-hand side of (10) is called the self-interference and reduces the noise margin. Consequently, the BER performance of the system will be degraded.

III. BER DERIVATION AND ANALYSIS

In this section, we will derive the BER performance of the above described OFDM system with an additive white Gaussian noise (AWGN) channel. After the up-conversion by using the quadrature modulation, the RF signal in (4) is transmitted over an AWGN channel. The received signal is

$$s_r(t) = \hat{s}(t) + n(t) \quad (11)$$

where $n(t) = n_I \cos \omega_c t + n_Q \sin \omega_c t$ and n_I and n_Q are zero-mean Gaussian random variables with identical variances $\sigma_{n_I}^2 = \sigma_{n_Q}^2 = \sigma_n^2 / 2$.

At the receiver, the down-converted signal is obtained by multiplying with cosine and sine waveforms of the LO at the

corresponding branch, followed by low-pass filtering (LPF). The base-band signal is given by

$$r(t) = LPF \left(\left(2 \left(I \left(1 + \frac{\varepsilon}{2} \right) \cos \left(\omega_c t + \frac{\phi}{2} \right) + Q \left(1 - \frac{\varepsilon}{2} \right) \sin \left(\omega_c t - \frac{\phi}{2} \right) + n_I \cos \omega_c t + n_Q \sin \omega_c t \right) \cos \omega_c t \right) \right. \\ \left. + j LPF \left(2 \left(I \left(1 + \frac{\varepsilon}{2} \right) \cos \left(\omega_c t + \frac{\phi}{2} \right) + Q \left(1 - \frac{\varepsilon}{2} \right) \sin \left(\omega_c t - \frac{\phi}{2} \right) + n_I \cos \omega_c t + n_Q \sin \omega_c t \right) \sin \omega_c t \right) \right) \quad (12)$$

After some calculations we have

$$r(t) = \left[I \left(1 + \frac{\varepsilon}{2} \right) \cos \frac{\phi}{2} - Q \left(1 + \frac{\varepsilon}{2} \right) \sin \frac{\phi}{2} \right] + j \left[-I \left(1 - \frac{\varepsilon}{2} \right) \sin \frac{\phi}{2} + Q \left(1 - \frac{\varepsilon}{2} \right) \cos \frac{\phi}{2} \right] + n_I + j n_Q \quad (13)$$

According to (6) and (7), (13) can be written as

$$r(t) = \alpha_1 x(t) + \alpha_2 x^*(t) + n_I + j n_Q \quad (14)$$

where α_1 and α_2 are calculated by (8) and (9), respectively.

The OFDM signal $x(t) = I(t) + jQ(t)$ is a summation of several waveforms and therefore can be considered as a complex stationary Gaussian process. Its I component $I(t)$ and Q component $Q(t)$ are independent and identically distributed with zero-mean and common variance $\sigma_I^2 = \sigma_Q^2 = \sigma^2$. We assume

$$I_1 = I(t), \quad I_2 = I(t + \tau) \quad Q_1 = Q(t), \quad Q_2 = Q(t + \tau) \quad (15)$$

Their joint probability density function can be expressed by

$$p(I_1, I_2, Q_1, Q_2) = p(I_1, I_2) p(Q_1, Q_2) \\ = \frac{1}{(2\pi\sigma^2)^2 (1 - \rho^2)} \exp \left(-\frac{(I_1^2 + Q_1^2) + (I_2^2 + Q_2^2) - 2\rho(I_1 I_2 + Q_1 Q_2)}{2\sigma^2(1 - \rho^2)} \right) \quad (16)$$

The autocorrelation function of the OFDM signal is given by

$$R_{xx}(\tau) = E \{ x^*(t) x(t + \tau) \} = E \{ (I_1 - jQ_1)(I_2 + jQ_2) \} \\ = [R_{II}(\tau) + R_{QQ}(\tau)] + j [R_{IQ}(\tau) - R_{QI}(\tau)] \quad (17)$$

Since I and Q are two independent Gaussian variables, $R_{II}(0) = R_{QQ}(0) = \sigma^2$ and $R_{IQ}(0) = R_{QI}(0) = 0$ hold. It follows that $R_{xx}(0) = 2R_{II}(0) = 2\sigma^2 = \sigma_x^2$. Similarly, we have $R_{x^*x^*}(0) = 2\sigma^2 = \sigma_x^2$.

The power of the desired signal can be calculated by

$$P_s = E [\alpha_1^* x^*(t) \cdot \alpha_1 x(t + \tau)] |_{\tau=0} = |\alpha_1|^2 R_{xx}(0) = |\alpha_1|^2 \sigma_x^2 \quad (18)$$

Similarly, the power of the image component is

$$P_i = E [\alpha_2^* x(t) \cdot \alpha_2 x^*(t + \tau)] |_{\tau=0} = |\alpha_2|^2 R_{x^*x^*}(0) = |\alpha_2|^2 \sigma_x^2 \quad (19)$$

The ratio of the interference signal power to the desired signal power is called the image rejection ratio (IRR), i.e.,

$$IRR = \frac{P_i}{P_s} = \frac{|\alpha_2|^2}{|\alpha_1|^2} = \frac{\frac{\varepsilon^2}{4} \cos^2 \frac{\phi}{2} + \sin^2 \frac{\phi}{2}}{\cos^2 \frac{\phi}{2} + \frac{\varepsilon^2}{4} \sin^2 \frac{\phi}{2}} \quad (20)$$

This value in dB is computed by $IRR(dB) = 10 \log(1 + IRR)$.

The power of the AWGN noise is

$$P_N = P_{N_I} + P_{N_Q} = \sigma_{N_I}^2 + \sigma_{N_Q}^2 = \sigma_N^2 \quad (21)$$

The ratio of the desired signal power to the sum of the interference signal power and noise power is therefore

$$SNR = \frac{P_s}{P_i + P_N} = \frac{|\alpha_1|^2 \sigma_x^2}{|\alpha_2|^2 \sigma_x^2 + \sigma_N^2} = \frac{|\alpha_1|^2 \sigma_x^2 / \sigma_N^2}{|\alpha_2|^2 \sigma_x^2 / \sigma_N^2 + 1} = \frac{|\alpha_1|^2 E_s / N_0}{|\alpha_2|^2 E_s / N_0 + 1} \quad (22)$$

It is well known that the BER of an uncoded BPSK or QPSK system with AWGN noise is given by $BER = Q(\sqrt{2SNR})$,

where $Q(x) = \frac{1}{\sqrt{2\pi}} \int_x^{+\infty} e^{-t^2/2} dt$. From (22), we can obtain the

following closed-form expression for the BER of an OFDM system with the BPSK or QPSK modulation scheme and AWGN channel.

$$BER = Q \left(\sqrt{2 \frac{|\alpha_1|^2 E_b / N_0}{|\alpha_2|^2 E_b / N_0 + 1}} \right) = Q \left(\sqrt{2 \frac{(\cos^2 \phi / 2 + \varepsilon^2 / 4 \sin^2 \phi / 2) E_b / N_0}{\varepsilon^2 / 4 \cos^2 \phi / 2 + \sin^2 \phi / 2} E_b / N_0 + 1} \right) \quad (23)$$

Without I/Q mismatching error, i.e. $\varepsilon=0$ and $\phi=0$, the formula (23) will be reduced to the simple form, $BER = Q(\sqrt{2E_b / N_0})$.

IV. NUMERICAL RESULTS AND DISCUSSIONS

In this section, the BER performance of the OFDM system with I/Q mismatching errors is carried out by simulations to verify the derived analytical results. The deployed OFDM system uses the QPSK constellation and has 64 sub-carriers, i.e., $N=64$.

Fig. 3 shows various constellations of the received OFDM signals with and without I/Q mismatching errors. When the I/Q mismatching error occurs with respect to only the amplitude or phase, the resulting signal constellation will only be extended without any rotation. If both the amplitude and phase have I/Q mismatching errors, the signal constellation is not only extended but also rotated. In contrast with other RF impairments such as phase noise and nonlinear amplifier, the I/Q mismatching error results in discrete values of ε and/or ϕ . This is also the reason why the signal constellation is rotated and divided into several parts instead of the integrated constellation. When the received SNR exceeds the decision threshold, it will make errors in the received data. Obviously, I/Q mismatching errors reduce the noise margin of the signal.

The self-interference (mirror image) component in the received signal will degrade the SNR, as shown in (22). The IRR versus ε and ϕ is illustrated in Fig. 4. At the origin $\varepsilon=0$ and $\phi=0$, the value of the IRR is also equal to zero, which indicates that the SNR is not influenced by the self-interference component. The SNR will be reduced when ε and ϕ increase.

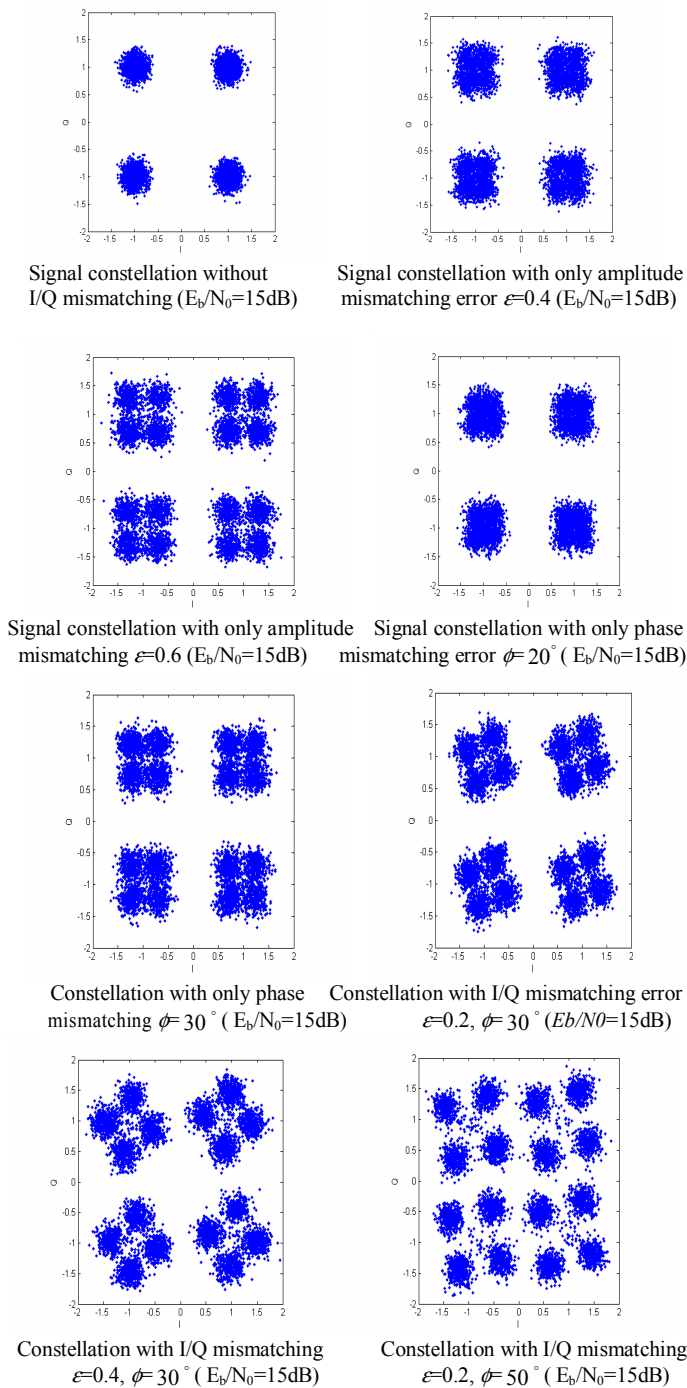

Fig.3. Constellations of OFDM signals with and without I/Q errors.

The loss of the SNR in the OFDM system results in the degradation of the BER performance. The simulation of the BER performance of the OFDM system was carried out to verify the analytical result in (24). Fig. 5 shows the BER performance of the OFDM system versus E_b/N_0 with only the phase I/Q mismatching error, i.e., $\epsilon=0$. BER curves are degraded as ϕ increases to 10° , 20° , 25° , and 30° . Note that the BER simulation results match the corresponding theoretical ones very well. At $BER=10^{-5}$, the OFDM system without the

phase I/Q error requires $E_b/N_0=9.5$ dB, while the OFDM system with $\phi=10^\circ$, 20° , 25° , and 30° need 9.95dB, 11.16dB, 12.3dB and 14.5dB, respectively. Fig.6 illustrates the BER performance of the OFDM system when only the amplitude I/Q mismatching errors $\epsilon=0.2, 0.3, 0.4$, and 0.5 require the additional E_b/N_0 of 0.5 dB, 1.08 dB, 2.05 dB, and 3.84 dB, respectively, at $BER=10^{-5}$.

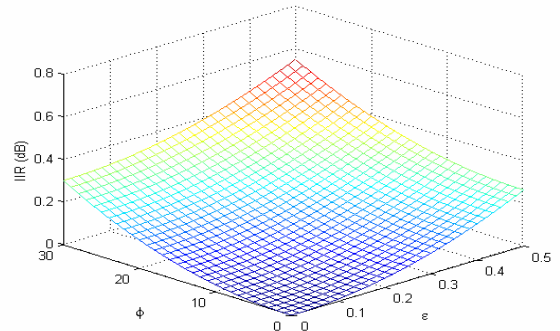

Fig.4. Image rejection ratio (IRR) in dB.

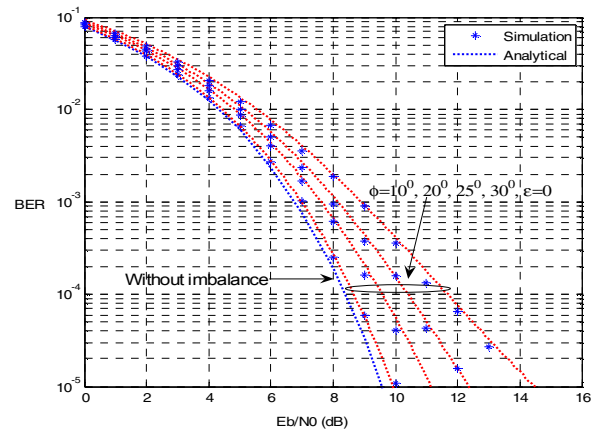

Fig.5. BER of the OFDM system with $\epsilon=0$ ($\phi=10^\circ, 20^\circ, 25^\circ, 30^\circ$).

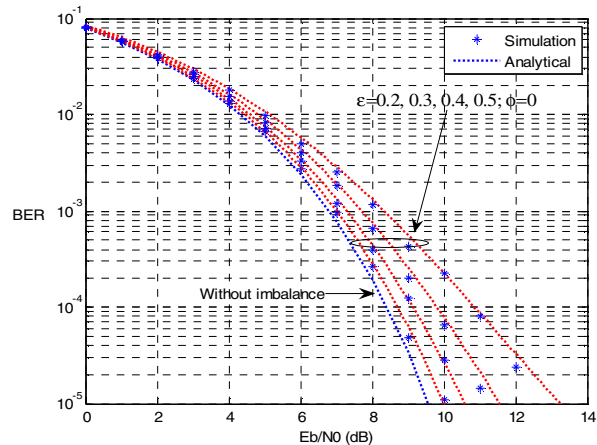

Fig.6. BER of the OFDM system with $\phi=0^\circ$ ($\epsilon=0.2, 0.3, 0.4, 0.5$).

Fig. 7 and 8 demonstrate the BER performance when both amplitude and phase mismatching errors are considered. In Fig. 7, when $\phi=10^\circ$, additional SNR of 0.88 dB, 1.51 dB, 2.59 dB, and 4.53 dB are required for $\epsilon=0.2, 0.3, 0.4$, and 0.5 , respectively, at $\text{BER}=10^{-5}$. In Fig. 8, when $\phi=20^\circ$, $\epsilon=0.1, 0.3, 0.4$, and 0.5 consume more SNRs of 1.8 dB, 3.12 dB, 4.72 dB, and 8.44 dB, respectively, at $\text{BER}=10^{-5}$. In all the cases (Figs. 5-8), the simulation results are very close to the analytical results. This clearly indicates that the closed-form expression of the BER in (24) can be used to estimate the performance of the OFDM system with I/Q mismatching errors.

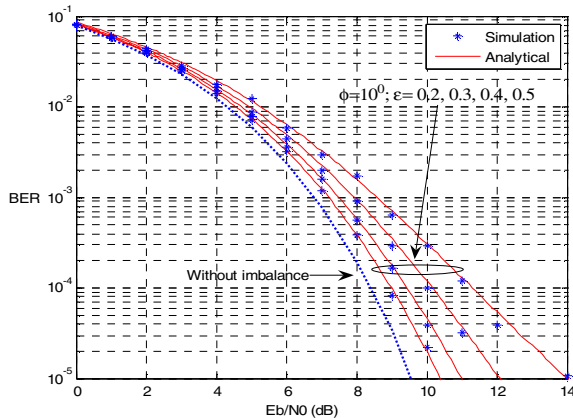

Fig. 7. BER of the OFDM system with $\phi=10^\circ$ ($\epsilon=0.2, 0.3, 0.4, 0.5$).

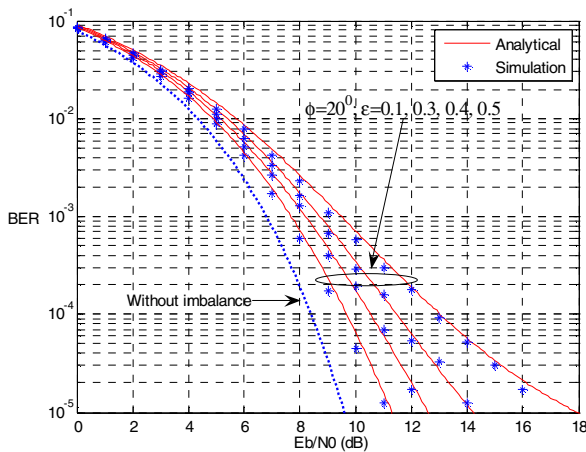

Fig. 8. BER of the OFDM system with $\phi=20^\circ$ ($\epsilon=0.1, 0.3, 0.4, 0.5$).

V. CONCLUSION

The mismatching error between I and Q branches of up-conversion can cause degradation in BER performance. In this paper, the effect of I/Q mismatching errors on OFDM systems has been investigated in detail. A closed-form expression for the BER of an OFDM system with I/Q mismatching errors has been derived. The resulting BER in a closed-form is expressed as a function of phase and amplitude mismatching error parameters. The influence of I/Q error parameters on the BER

performance has been studied by simulations. All the simulation results are very close to the corresponding analytical results. So, this verifies the correctness of the BER derivation.

ACKNOWLEDGEMENT

Prof. Heung-Gyoon Ryu and Dr. Cheng-Xiang Wang would like to acknowledge the support of The Royal Society of Edinburgh.

REFERENCES

- [1] *Part 11: Wireless LAN Medium Access Control (MAC) and Physical Layer (PHY) Specifications: High-Speed Physical Layer in the 5GHz Band*, IEEE Standard 802.11a-1999.
- [2] *Local and Metropolitan Area Networks - Part 16, Air Interface for Fixed Broadband Wireless Access System*, IEEE Standard 802.16a.
- [3] U. Reimers, "Digital Video Broadcasting," *IEEE Commun. Mag.*, vol. 36, Issue 6, pp. 104-110, June 1998.
- [4] A. A. Abidi, "Direct-conversion radio transceivers for digital communications," *IEEE Journal of Solid-State Circuits*, vol. 30, Issue 12, pp. 1399 – 1410, Dec. 1995.
- [5] B. Razavi, "Design considerations for direct-conversion receivers," *IEEE Transactions on Circuits and Systems II*, vol. 44, Issue 6, pp. 428 – 435, Jun. 1997.
- [6] B. Razavi, *RF Microelectronics*, Prentice Hall, Upper Saddle River, NJ, 1998.
- [7] C.L. Liu, "Impacts of I/Q mismatching error on QPSK-OFDM-QAM detection," *IEEE Transactions on Consumer Electronics*, vol. 44, Issue 3, pp. 984 – 989, Aug. 1998.
- [8] M. Buchholz, A. Schuchert, R. Hasholzner, "Effects of tuner I/Q mismatching error on multicarrier-modulation systems," *Proc. IEEE International Caracas Conference on Devices, Circuits and Systems*, pp. T65/1 - T65/6, Mar. 2000.
- [9] A. Tarighat, A. H. Sayed, "MIMO OFDM Receivers for Systems With IQ Mismatching errors," *IEEE Transactions on Signal Processing*, vol. 53, Issue 9, pp. 3583 – 3596, Sept. 2005.
- [10] H. Shafiee, S. Fouladifard, "Calibration of IQ mismatching error in OFDM transceivers," *IEEE International Conference on Communications ICC '03*, vol. 3, pp. 2081 – 2085, May 2003.
- [11] J. Tubbax, et al., "Joint compensation of IQ mismatching error and frequency offset in OFDM systems," *IEEE Global Telecommunications Conference GLOBECOM '03*, vol. 4, pp. 2365 – 2369, Dec. 2003.
- [12] J. Tubbax, et al., "Compensation of IQ mismatching error and phase noise in OFDM systems," *IEEE Transactions on Wireless Communications*, vol. 4, Issue 3, pp. 872 – 877, May 2005.
- [13] M. Valkama, M. Renfors, V. Koivunen, "Advanced methods for I/Q mismatching error compensation in communication receivers," *IEEE Transactions on Signal Processing*, vol. 49, Issue 10, pp. 2335 – 2344, Oct. 2001.
- [14] A. Schuchert, R. Hasholzner, P. Antoine, "A novel IQ mismatching error compensation scheme for the reception of OFDM signals," *IEEE Transactions on Consumer Electronics*, vol. 47, Issue 3, pp. 313 – 318, Aug. 2001.
- [15] P. Baudin, F. Belveze, "Impact of RF impairments on a DS-SS-CDMA receiver," *IEEE Transactions on Communications*, vol. 52, Issue 1, pp. 31 – 36, Jan. 2004.
- [16] P. Rykaczewski, M. Valkama, M. Renfors, "Analytical approach to I/Q mismatching error in OFDM, CDMA and MC-CDMA based systems," *IEEE Radio and Wireless Symposium*, pp. 555 – 558, 2006.